

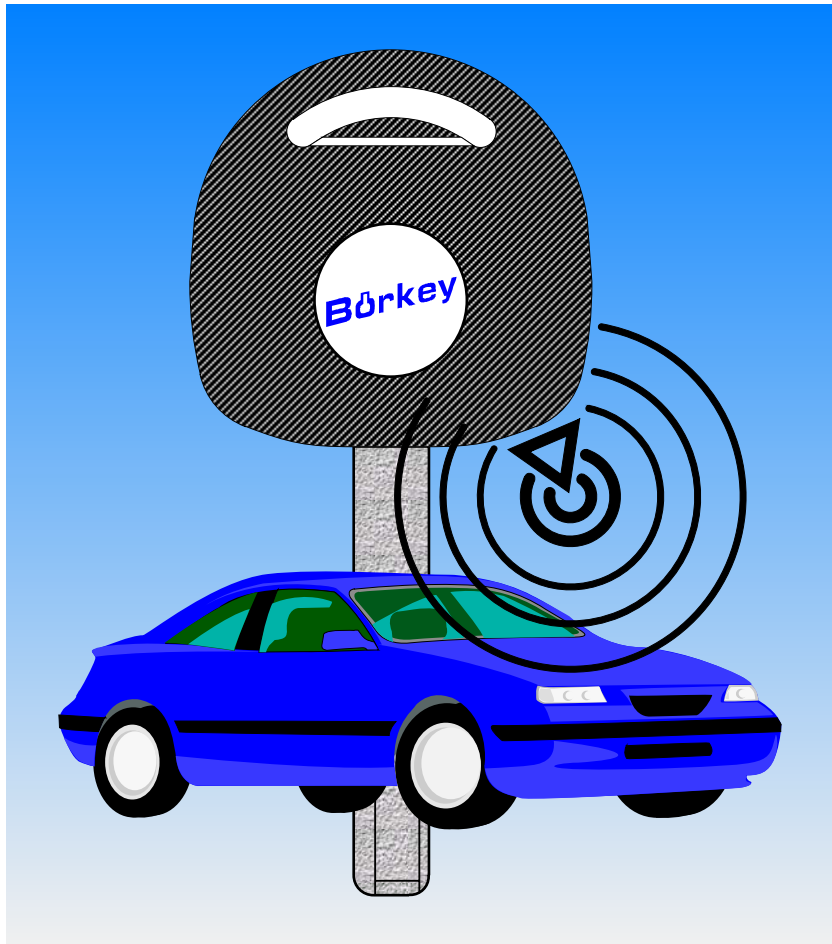

**Börkey**<sup>®</sup>



**TRANSPONDERSCHLÜSSEL**

**TRANSPONDER LESE- UND KOPIERGERÄT**

**DIAGNOSE ELEKTRONIKBOX**



## AUFBAU ARTIKELNUMMER TRANSPONDERSCHLÜSSEL

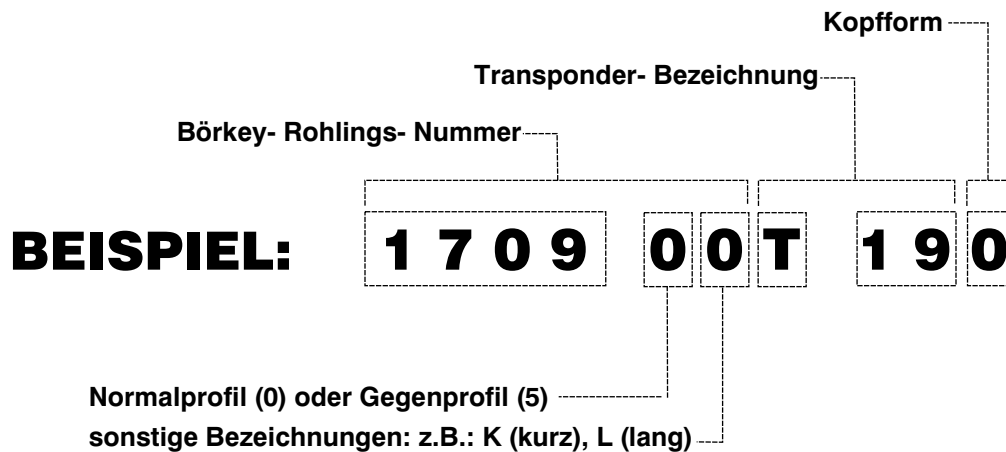

Transponder- Bezeichnung	<div style="display: flex; gap: 10px;"> <div style="border: 1px dashed black; padding: 2px;">□□□□</div> <div style="border: 1px dashed black; padding: 2px;">□□</div> </div>	<p>T 01 = Philips Crypto (PH/CR)</p> <p>T 02 = Philips Crypto (PH/CR)</p> <p>T 03 = Texas Crypto (TEX/CR)</p> <p>T 08 = Texas Crypto (TEX/CR)</p> <p>T 09 = Philips Crypto (PH/CR)</p> <p>T 10 = Philips (PH)</p> <p>T 11 = Philips Crypto (PH/CR)</p> <p>T 13 = Philips (PH)</p> <p>T 19 = Silca (Nova)</p> <p>T 30 = Texas</p> <p>T 31 = Texas</p> <p>T 32 = Texas Crypto (TEX/CR)</p> <p>T 42 = Megamos Crypto (MEG/CR)</p>
--------------------------	--	--

(siehe auch Seite 18)

### Für die Datenübertragung der Transponderschlüssel stehen 2 Transfer- Geräte zur Verfügung:

1. Für das Kopieren und Codieren der Transponder mit fixem Code.
2. Für die Programmierung von Schlüsseln in der Steuerzentrale der Wegfahrsperrung des Fahrzeuges.

Im Bedarfsfall bitten wir um Ihre Anfrage.

In der Regel können die Transponderschlüssel auch im Schlüsseldienst mechanisch bearbeitet und in der KFZ- Vertragswerkstatt mit den Elektronik- Daten programmiert werden.

# ÜBERSICHT NACH KFZ- HERSTELLERN



HERSTELLER	MODELL	BAUJAHR	SCHLÜSSEL-NR.		ORIGINAL- TRANSPONDER	DATENTRANSFER							
			BÖRKEY	SILCA		BÖRKEY			MASTER- SCHLÜSSEL	JEDER SCHLÜSSEL	WERKSTATT	SILCA	
						TLKG I	TLKG II	DIAGNOSE				RW2	SDD
<b>ACURA</b>													
	3.5 RL	1997-	1488 0LT 190	HON58RT5	MEG		X					X	
	CL & TL	1999-	1488 0LT 190	HON58RT5	MEG		X					X	
	MD-X	2001-	1488 0LT 190	HON58RT5	MEG		X					X	
	NSX	1997-	1488 0LT 190	HON58RT5	MEG		X					X	
<b>ALFA ROMEO</b>													
	145	1995-	1505 0NT 100	GT15RT2	PH		X					X	
	146	1995-	1505 0NT 100	GT15RT2	PH		X					X	
	155	1995-	1505 0NT 100	GT15RT2	PH		X					X	
	164	1995-	1758 00T 100	GT16T2	PH		X					X	
	GTV	1995-	1505 0NT 100	GT15RT2	PH		X					X	
	SPIDER	1995-	1505 0NT 100	GT15RT2	PH		X					X	
<b>AUDI</b>													
	80	1996-	1382 00T 190	HU49AT5	MEG		X					X	
	A2	2000-	1709 00T 420	HU66AT6	MEG/CR			X					X
	A3	1996-1997	1709 00T 190	HU66AT5	MEG		X					X	
	A3	1997-	1709 00T 420	HU66AT6	MEG/CR			X					X
	A4	1995-1996	1382 00T 190	HU49AT5	MEG		X					X	
	A4	1996-1997	1709 00T 190	HU66AT5	MEG		X					X	
	A4	1997-	1709 00T 420	HU66AT6	MEG/CR			X					X
	A6	1995-1996	1382 00T 190	HU49AT5	MEG		X					X	
	A6	1996-1997	1709 00T 190	HU66AT5	MEG		X					X	
	A6	1997-	1709 00T 420	HU66AT6	MEG/CR			X					X
	A8	1995-1996	1382 00T 190	HU49AT5	MEG		X					X	
	A8	1996-1997	1709 00T 190	HU66AT5	MEG		X					X	
	A8	1997-	1709 00T 420	HU66AT6	MEG/CR			X					X
	ALLROAD QUATTRO	2000-	1709 00T 420	HU66AT6	MEG/CR			X					X
	COUPE'	1995-1996	1382 00T 190	HU49AT5	MEG		X					X	
	COUPE'	1996-1997	1709 00T 190	HU66AT5	MEG		X					X	
	COUPE'	1997-	1709 00T 420	HU66AT6	MEG/CR			X					X
	COUPE' S2	1995-1996	1382 00T 190	HU49AT5	MEG		X					X	
	COUPE' S2	1996-1997	1709 00T 190	HU66AT5	MEG		X					X	
	COUPE' S2	1997-	1709 00T 420	HU66AT6	MEG/CR			X					X
	S3	2001-	1709 00T 420	HU66AT6	MEG/CR			X					X
	S6	1995-1996	1382 00T 190	HU49AT5	MEG		X					X	
	S6	1996-1997	1709 00T 190	HU66AT5	MEG		X					X	
	S6	1997-	1709 00T 420	HU66AT6	MEG/CR			X					X
	TT COUPE'	1998-	1709 00T 420	HU66AT6	MEG/CR			X					X
<b>CITROEN</b>													
	BERLINGO	1998-	1602 00T 190	SX9T5	PH		X					X	
	EVASION	1998-	1602 00T 190	SX9T5	PH		X					X	
	SAXO	1998-	1602 00T 190	SX9T5	PH		X					X	
	XANTIA	1998-1999	1602 00T 190	SX9T5	PH		X					X	
	XANTIA	1999-	1602 00T 420	SX9T6	MEG/CR						X		X
	XSARA 1.8	1998-	1602 00T 190	SX9T5	PH		X					X	
<b>DAEWOO</b>													
	ESPERO	1995-	1352 00T 19A	HU46AT5	MEG		X					X	
	LANOS	1997-	1760 00T 190	DWO5RT5	MEG		X					X	
	LEGANZA	1997-	1760 50T 190	DWO5T5	MEG		X					X	
	NEXIA	1995-	1352 00T 19A	HU46AT5	MEG		X					X	
	NUBIRA	1997-	1759 0LT 190	DWO4RT5	MEG		X					X	
	MATIZ	1998-	1759 5KT 19A	DWO6BT5	MEG		X					X	

HERSTELLER	MODELL	BAUJAHR	SCHLÜSSEL-NR.		ORIGINAL- TRANSPONDER	DATENTRANSFER						
			BÖRKEY	SILCA		BÖRKEY			Werkstatt	SILCA		
						TLKG I	TLKG II	DIAGNOSE		MASTER-SCHLÜSSEL	JEDER SCHLÜSSEL	RW2
<b>DAIHATSU</b>												
	CUORE	1998-	1489 00T 310	DH4RT4	TEXAS						X	
	CUORE	1998-	1733 00T 310	DH5RT4	TEXAS						X	
	MOVE	1997-	1733 00T 310	DH5RT4	TEXAS						X	
	TERIOS	1997-	1489 00T 310	DH4RT4	TEXAS						X	
	SIRION	1998-	1489 00T 310	DH4RT4	TEXAS						X	
<b>FIAT</b>												
	BARCETTA	1995-	1505 0NT 19D	GT15RAT5	MEG		X		X			X
	BRAVA	1995-	1505 0NT 19B	GT15RBT5	MEG		X		X			X
	BRAVA	1997-	1505 0NT 19C	GT15RCT5	TEMIC		X		X			X
	BRAVO	1995-	1505 0NT 19B	GT15RBT5	MEG		X		X			X
	BRAVO	1997-	1505 0NT 19C	GT15RCT5	TEMIC		X		X			X
	CINQUECENTO	1995-	1375 00T 190	GT10BT5	MEG		X		X			X
	CINQUECENTO	1997-	1505 0NT 19B	GT15RBT5	MEG		X		X			X
	COUPE'	1995-	1505 0NT 19D	GT15RAT5	PH		X		X			X
	CROMA	1995-	1375 00T 190	GT10BT5	PH		X		X			X
	DUCATO	1996-	1375 00T 190	GT10BT5	MEG		X		X			X
	FIORINO	1995-	1375 00T 190	GT10BT5	TEMIC		X		X			X
	MAREA	1996-	1505 0NT 19C	GT15RCT5	TEMIC		X		X			X
	MARENGO	1996-	1505 0NT 19B	GT15RBT5	MEG		X		X			X
	PALIO	1996-	1505 0NT 19C	GT15RCT5	TEMIC		X		X			X
	PANDA	1995-	1375 00T 190	GT10BT5	MEG		X		X			X
	PUNTO	1995-1999	1505 0NT 19D	GT15RAT5	MEG		X		X			X
	SCUDO	1996-	1602 00T 190	SX9T5	PH		X					X
	SEICENTO	1995-	1375 00T 190	GT10BT5	MEG		X		X			X
	SEICENTO	1997-	1505 0NT 19B	GT15RBT5	MEG		X		X			X
	TEMPRA	1995-1996	1505 0NT 19B	GT15RBT5	MEG		X		X			X
	ULYSSE	1996-	1602 00T 190	SX9T5	PH		X					X
<b>FORD</b>												
	COUGAR	1997-1997	1455 00T 300	FO21T3	TEXAS				X			
	COURIER KOMBI	1998-	1455 00T 300	FO21T3	TEXAS				X			
	ESCORT	1995-	1455 00T 300	FO21T3	TEXAS				X			
	FIESTA	1995-	1455 00T 300	FO21T3	TEXAS				X			
	FOCUS	1998-	1455 00T 320	FO21T7	TEX/CR					X		
	GALAXY	1995-1998	1709 00T 10A	HU66BT1	PH		X					X
	GALAXY	1998-2000	1709 00T 01B	HU66T10	PH					X		X
	KA	1996-	1455 00T 300	FO21T3	TEXAS				X			
	MAVERICK	1995-	1362 00T 100	NSN11T2	PH		X					X
	MONDEO	1995-	1455 00T 300	FO21T3	TEXAS				X			
	MONDEO	2001-	1455 00T 320	FO21T7	TEX/CR					X		
	PROBE	1996-	1556 00T 190	MAZ13T5	TEMIC		X					X
	PUMA	1998-	1455 00T 300	FO21T3	TEXAS				X			
	SCORPIO	1995-	1455 00T 300	FO21T3	TEXAS				X			
	TRANSIT	1995-1998	1455 00T 300	FO21T3	TEXAS				X			
	TRANSIT	2000-	1455 00T 320	FO21T7	TEX/CR					X		
<b>HONDA</b>												
	ACCORD	1995-1998	1594 00T 100	NE77RT2	PH		X					X
	ACCORD	1999-	1594 0NT420	HON65RT6	MEG/CR					X		X
	ACCORD AERO DECK	1995-	1488 0LT 190	HON58RT5	MEG		X					X
	ACCORD COUPE'	1995-	1488 0LT 190	HON58RT5	MEG		X					X
	CIVIC	1995-	1594 00T 100	NE77RT2	PH		X					X
	CIVIC 3p NEW AGE	1995-	1488 0LT 190	HON58RT5	MEG		X					X
	CR-V	1997-	1488 0LT 190	HON58RT5	MEG		X					X

# ÜBERSICHT NACH KFZ- HERSTELLERN



HERSTELLER	MODELL	BAUJAHR	SCHLÜSSEL-NR.		ORIGINAL- TRANSPONDER	DATENTRANSFER								
			BÖRKEY	SILCA		BÖRKEY			MAKER- SCHLÜSSEL	JEDER SCHLÜSSEL	WERKSTATT	SILCA		
						TLKG I	TLKG II	DIAGNOSE				RW2	SDD	
<b>HONDA</b>														
	HR-V	2000-	1488 0LT 420	HON58RT6	MEG/CR							X		X
	LEGEND	1997-	1488 0LT 190	HON58RT5	MEG		X						X	
	LOGO	2000-	1488 0LT 420	HON58RT6	MEG/CR							X		X
	PASSPORT	1998-	1488 0LT 190	HON58RT5	MEG		X						X	
	PRELUDE	1997-	1488 0LT 190	HON58RT5	MEG		X						X	
	SHUTTLE	1995-2000	1488 0LT 190	HON58RT5	MEG		X						X	
	SHUTTLE	2000-	1488 0LT 420	HON58RT6	MEG/CR							X		X
<b>HYUNDAI</b>														
	ACCENT	1996-1999	1700 00T 310	HYN10T4	TEXAS				X					
	ATOS	1998-	1700 00T 310	HYN10T4	TEXAS				X					
	ATOS PRIME	2000-	1700 00T 310	HYN10T4	TEXAS							X		
	COUPE'	1996-	1638 00T 310	HYN6T4	TEXAS				X					
	GALOPPER	1999-	1638 00T 310	HYN6T4	TEXAS				X					
	ELANTRA (USA)	1996-	1638 00T 310	HYN6T4	TEXAS				X					
	EXCEL	1996-1999	1700 00T 310	HYN10T4	TEXAS				X					
	LANTRA	1996-	1638 00T 310	HYN6T4	TEXAS				X					
	SANTAMO	2000-	1638 00T 310	HYN6T4	TEXAS							X		
	SCOUPE'	1996-	1638 00T 310	HYN6T4	TEXAS				X					
	SONICA	1996-1999	1761 00T 310	HYN7RT4	TEXAS				X					
	SONATA	1996-1998	1761 00T 310	HYN7RT4	TEXAS				X					
	STAREX	1998-	1638 00T 310	HYN6T4	TEXAS				X					
<b>JAGUAR</b>														
	SOVEREIGN	1996-	1538 00T 190	TBE1T5	MEG		X						X	
	XJ, XJS, XK8	1998-1999	1538 00T 190	TBE1T5	MEG		X						X	
<b>KIA</b>														
	CLARUS	1998-	1772 00T 190	KIA3RT5	MEG		X						X	
	CLARUS	1998-	1772 50T 190	KIA3T5	MEG		X						X	
	SHUMA	1998-	1772 50T 190	KIA3T5	MEG		X						X	
	SPORTAGE	1998-1999	1772 00T 190	KIA3RT5	MEG		X						X	
<b>LANCIA</b>														
	DEDRA	1995-1997	1505 0NT 19E	GT18RT5	MEG		X						X	
	DEDRA	1997-	1505 0NT 19E	GT18RT5	TEMIC		X						X	
	DELTA	1995-	1505 0NT 19E	GT18RT5	MEG		X						X	
	K	1995-	1757 00T 130	SIP16T2	PH		X						X	
	K COUPE'	1997-	1757 00T 130	SIP16T2	PH		X						X	
	Y	1995-	1505 0NT 19E	GT18RT5	TEMIC		X						X	
	Z 2000	1998-	1602 00T 190	SX9T5	PH		X						X	
<b>LEXUS</b>														
	GS 300/ 400	1998-	1796 00T 310	TOY48BT4	TEXAS							X		
	GS/ LS/ LX	1998-	1796 00T 310	TOY48BT4	TEXAS							X		
	IS 200	1999-	1796 00T 310	TOY48BT4	TEXAS							X		
	LS 200	1999-	1796 00T 310	TOY48BT4	TEXAS							X		
	LS 400	1997-	1558 00T 31A	TOY40BT4	TEXAS							X		
	LS 400	1999-	1796 00T 310	TOY48BT4	TEXAS							X		
	LX 450	1998-	1558 00T 31A	TOY40BT4	TEXAS							X		
	LX 470	1999-	1558 00T 31A	TOY40BT4	TEXAS							X		
	RX 300	1999-	1796 00T 310	TOY48BT4	TEXAS							X		
<b>MALAGUTI</b>														
	F15 FIREFOX	1996-	1766 00T 190	ZD23RT5	TEMIC		X						X	

HERSTELLER	MODELL	BAUJAHR	SCHLÜSSEL-NR.		ORIGINAL- TRANSPONDER	DATENTRANSFER						
			BÖRKEY	SILCA		BÖRKEY			Werkstatt	SILCA		
						TLKG I	TLKG II	DIAGNOSE		MASTER-SCHLÜSSEL	JEDER SCHLÜSSEL	RW2
<b>MAZDA</b>												
	626 (ES, LS, LUX)	1998-1999	1762 00T 190	MAZ24RT5	PH		X					X
	MX-3	1995-	1556 00T 190	MAZ13T5	TEMIC		X					X
	MX-5	1995-	1556 00T 190	MAZ13T5	TEMIC		X					X
	MX-5	1998-	1762 00T 190	MAZ24RT5	PH		X					X
	MX-6	1995-	1651 00T 190	MAZ20RT5	TEMIC		X					X
	XEDOS 6	1995-	1651 00T 190	MAZ20RT5	TEMIC		X					X
	XEDOS 9	1995-	1558 00T 190	MIT14T5	TEMIC		X					X
<b>MERCEDES</b>												
	ACTROS	1997-	0892 00T 190	YM15T5	MEG		X					X
	ACTROS	1998-	0892 00T 190	YM15T5	TEMIC		X					X
	SPRINTER	1997-	0892 00T 190	YM15T5	TEMIC		X					X
	VITO	1998-	0892 00T 190	YM15T5	MEG		X					X
	VITO	1999-	0892 00T 190	YM15T5	TEMIC		X					X
<b>MBK</b>												
	BOOSTER	1997-	1766 00T 190	ZD23RT5	TEMIC		X					X
	BOOSTER	1999-	1766 0LT 190	ZD24RT5	TEMIC		X					X
<b>MITSUBISHI</b>												
	CARISMA	1996-2000	1474 00T 10A	HU56RT2	PH		X					X
	COLT	1996-	1643 00T 310	MIT11RT4	TEXAS						X	
	ECLIPSE	1996-	1509 00T 310	MIT8T4	TEXAS						X	
	FOCUS	1998-	1509 00T 310	MIT8T4	TEXAS						X	
	GALANT	1996-2000	1509 00T 310	MIT8T4	TEXAS						X	
	LANCER	1996-	1643 00T 310	MIT11RT4	TEXAS						X	
	MAGNA	1996-2000	1558 00T 190	MIT14T5	PH		X					X
	PAJERO	1996-	1509 00T 310	MIT8T4	TEXAS						X	
	SPACE GEAR	1996-	1509 00T 310	MIT8T4	TEXAS						X	
	SPACE RUNNER	1998-1999	1509 00T 310	MIT8T4	TEXAS						X	
<b>NISSAN</b>												
	ALMERA	2000-	1763 00T 030	NSN14T13	TEX/CR						X	
	ALMERA	2000-	1763 00T 03A	NSN14AT13	TEX/CR						X	
	ALMERA TINO	2000-	1763 00T 030	NSN14T13	TEX/CR						X	
	ALMERA TINO	2000-	1763 00T 03A	NSN14AT13	TEX/CR						X	
	MAXIMA	1999-	1362 00T 110	NSN11T11	PH/CR						X	
	MAXIMA	1999-	1362 00T 11A	NSN11AT11	PH/CR						X	
	MAXIMA	1995-1999	1362 00T 100	NSN11T2	PH		X					X
	MICRA	1996-1998	1362 00T 100	NSN11T2	PH		X					X
	MICRA	1998-	1362 00T 110	NSN11T11	PH/CR						X	
	MICRA	1998-2000	1362 00T 11A	NSN11AT11	PH/CR						X	
	MICRA	2000-	1362 00T 030	NSN11T13	TEX/CR						X	
	MICRA	2000-	1362 00T 03A	NSN11AT13	TEX/CR						X	
	MICRA VAN	2000-2000	1362 00T 110	NSN11T11	PH/CR						X	
	MICRA VAN	2000-2000	1362 00T 11A	NSN11AT11	PH/CR						X	
	MICRA VAN	2000-	1362 00T 030	NSN11T13	TEX/CR						X	
	MICRA VAN	2000-	1362 00T 03A	NSN11AT13	TEX/CR						X	
	NX ALMERA	1995-1998	1362 00T 100	NSN11T2	PH		X					X
	NX ALMERA	1998-2000	1362 00T 110	NSN11T11	PH/CR						X	
	NX ALMERA	1998-2000	1362 00T 11A	NSN11AT11	PH/CR						X	
	PATROL	1999-2000	1763 00T 110	NSN14T11	PH/CR						X	
	PATROL	1998-2000	1763 00T 110	NSN14AT11	PH/CR						X	
	PRIMERA	1995-1996	1362 00T 100	NSN11T2	PH		X					X
	PRIMERA	1997-1998	1763 00T 190	NSN14T5	PH		X					X

# ÜBERSICHT NACH KFZ- HERSTELLERN



HERSTELLER	MODELL	BAUJAHR	SCHLÜSSEL-NR.		ORIGINAL-TRANSPONDER	DATENTRANSFER							
			BÖRKEY	SILCA		BÖRKEY			WERKSTATT	SILCA			
						TLKG I	TLKG II	DIAGNOSE		MASTER-SCHLÜSSEL	JEDER SCHLÜSSEL	RW2	SDD
<b>NISSAN</b>													
	PRIMERA	1998-2000	1763 00T 030	NSN14T13	TEX/CR							X	
	PRIMERA	1998-2000	1763 00T 03A	NSN14AT13	TEX/CR							X	
	PRIMERA	2000-	1763 00T 03A	NSN14T11	PH/CR							X	
	PRIMERA	2000-	1362 00T 11A	NSN14AT11	PH/CR							X	
	PULSAR	1995-1996	1362 00T 100	NSN11T2	PH		X						X
	PULSAR	1997-1998	1763 00T 190	NSN14T5	PH		X						X
	PULSAR	1998-2000	1763 00T 030	NSN14T13								X	
	PULSAR	1998-2000	1763 00T 03A	NSN14AT13								X	
	PULSAR	2000-	1763 00T 11A	NSN14T11								X	
	PULSAR	2000-	1763 00T 11A	NSN14AT11								X	
	SERENA	1996-	1362 00T 100	NSN11T2	PH		X						X
	TERRANO II	1995-1998	1362 00T 100	NSN11T2	PH		X						X
	TERRANO II	1998-	1362 00T 110	NSN11T11								X	
	TERRANO II	1998-	1362 00T 11A	NSN11AT11								X	
	VANETTE CARGO	1996-	1362 00T 100	NSN11T2	PH		X						X
<b>OPEL</b>													
	ASTRA	1995-1998	1352 00T 100	HU46T2	PH		X						X
	ASTRA	1995-1998	1352 50T 100	YM28T2	PH		X						X
	ASTRA	1998-2001	1352 50T 09A	YM28AT9	PH/CR							X	X
	ASTRA	1998-2001	1352 00T 090	HU46T9	PH/CR							X	X
	ASTRA	1998-2001	1352 00T 09A	HU46AT9	PH/CR							X	X
	ASTRA	2001-	1352 50T 02A	YM28AT12	PH/CR							X	X
	ASTRA	2001-	1352 00T 020	HU46T12	PH/CR							X	X
	ASTRA	2001-	1352 00T 02A	HU46AT12	PH/CR							X	X
	CALIBRA	1995-1998	1335 00T 100	HU43T2	PH		X						X
	CALIBRA	1995-1998	1334 00T 100	YM27T2	PH		X						X
	COMBO	1998-	1352 00T 100	HU46T2	PH		X						X
	COMBO	1998-	1374 0LT 190	NE73T5	PH		X						X
	CORSA	1995-1998	1352 00T 100	HU46T2	PH		X						X
	CORSA	1995-1998	1352 50T 100	YM28T2	PH		X						X
	CORSA	1998-1999	1352 00T 09A	HU46AT9	PH/CR							X	X
	CORSA	1998-1999	1352 00T 090	HU46T9	PH/CR							X	X
	CORSA	1998-1999	1352 50T 09A	YM28AT9	PH/CR							X	X
	CORSA	2000-	1352 00T 02B	HU46BT12	PH/CR							X	X
	FRONTERA	1996-1999	1507 00T 190	GM15T5	MEG		X						X
	FRONTERA	1999-	1488 0LT 420	HON58RT6	MRG/CR							X	X
	MOVANO	1999-2000	1374 0LT 190	NE73T5	PH		X						X
	OMEGA	1995-	1335 00T 100	HU43T2	PH		X						X
	OMEGA	1995-	1334 00T 100	YM27T2	PH		X						X
	SINTRA	1997-	1335 00T 100	HU43T2	PH		X						X
	TIGRA	1995-1998	1352 00T 100	HU46T2	PH		X						X
	TIGRA	1995-1998	1352 50T 100	YM28T2	PH		X						X
	TIGRA	1998-2001	1352 00T 09A	HU46AT9	PH/CR							X	X
	TIGRA	1998-2001	1352 00T 090	HU46T9	PH/CR							X	X
	TIGRA	1998-2001	1352 50T 09A	YM28AT9	PH/CR							X	X
	TIGRA	2001-	1352 50T 02A	YM28AT12	PH/CR							X	X
	TIGRA	2001-	1352 00T 020	HU46T12	PH/CR							X	X
	TIGRA	2001-	1352 00T 02A	HU46AT12	PH/CR							X	X
	VECTRA	1995-1998	1335 00T 100	HU43T2	PH		X						X
	VECTRA	1995-1998	1334 00T 100	YM27T2	PH		X						X
	VECTRA	1998-	1335 00T 09A	HU43AT9	PH/CR							X	X
	VECTRA	1998-	1335 00T 090	HU43T9	PH/CR							X	X
	ZAFIRA	1999-	1335 00T 09A	HU43AT9	PH/CR							X	X
	ZAFIRA	1999-	1335 00T 090	HU43T9	PH/CR							X	X

HERSTELLER	MODELL	BAUJAHR	SCHLÜSSEL-NR.		ORIGINAL-TRANSPONDER	DATENTRANSFER							
			BÖRKEY	SILCA		BÖRKEY			Werkstatt	SILCA			
						TLKG I	TLKG II	DIAGNOSE		MASTER-SCHLÜSSEL	JEDER SCHLÜSSEL	RW2	SDD
<b>PEUGEOT</b>													
	ALISE'	1998-	1797 00T 190	NE74T5	TEMIC		X					X	
	ELISEO	1998-	1797 00T 190	NE74T5	TEMIC		X					X	
	106	1997-	1374 0BT 190	NE72AT5	PH		X					X	
	306	1997-	1374 0BT 190	NE72AT5	PH		X					X	
	406	1997-1999	1714 00T 190	NE78T5	PH		X					X	
	806	1998-	1602 00T 190	SX9T5	PH		X					X	
	RANSCH	1998-2000	1602 00T 190	SX9T5	PH		X					X	
	SPEEDFIGHT	1997-	1797 00T 190	NE74T5	TEMIC		X					X	
<b>PIAGGIO</b>													
	VESPA	1996-	1505 0NT 19A	GT15RDT5	TEMIC		X		X			X	
	SOME MODELS	1996-	1505 0NT 19A	GT15RDT5	TEMIC		X		X			X	
<b>PORSCHE</b>													
	BOXTER	1997-1998	1709 00T 19B	HU66T5	MEG		X					X	
	911	1998-1999	1709 00T 19B	HU66T5	MEG		X					X	
<b>PROTON</b>													
	415	1996-1998	1765 00T 310	PO1RT4	TEXAS					X			
	416	1996-1998	1765 00T 310	PO1RT4	TEXAS					X			
<b>RENAULT</b>													
	CLIO	1995-	1655 00T 100	VAC102T1	PH		X					X	
	CLIO	1995-2001	1374 0LT 190	NE73T5	PH		X					X	
	ESPACE	1997-	1374 0LT 190	NE73T5	PH		X					X	
	LAGUNA	1995-	1374 0LT 190	NE73T5	PH		X					X	
	LAGUNA	1995-	1655 00T 100	VAC102T1	PH		X					X	
	KANGOO	1998-	1655 00T 100	VAC102T1	PH		X					X	
	MEGANE	1996-1998	1374 0LT 190	NE73T5	PH		X					X	
	MEGANE	1998-	1374 0LT 080	NE73T8						X			
	SAFRANE	1995-	1374 0LT 190	NE73T5	PH		X					X	
	SAFRANE	1995-	1655 00T 100	VAC102T1	PH		X					X	
	TWINGO	1995-	1655 00T 100	VAC102T1	PH		X					X	
<b>ROVER</b>													
	600	1998-	1594 00T 100	NE77RT2	PH		X					X	
	618	1996-	1594 00T 100	NE77RT2	PH		X					X	
	620	1996-	1594 00T 100	NE77RT2	PH		X					X	
<b>SAAB</b>													
	9-3	1998-	1424 00T 190	YM30T5	MEG		X					X	
	9-5	1998-	1424 00T 190	YM30T5	MEG		X					X	
<b>SEAT</b>													
	AROSA	1997-1999	1709 00T 19B	HU66T5	PH		X					X	
	AROSA	1999-2001	1709 00T 01B	HU66T10	PH/CR					X			X
	ALHAMBRA	1996-1998	1709 00T 19B	HU66T5	PH		X					X	
	ALHAMBRA	1998-2000	1709 00T 01B	HU66T10	PH/CR					X			X
	CORDOBA	1995-	1382 0T1 107	HU49T5	PH	X	X					X	
	CORDOBA VARIO	1999-	1709 00T 01B	HU66T10	PH/CR					X			X
	IBIZA	1995-1998	1382 0T1 107	HU49T5	PH	X	X					X	
	IBIZA	1998-	1709 00T 01B	HU66T10	PH/CR					X			X
	INCA	1996-	1382 0T1 107	HU49T5	PH	X	X					X	
	LEON	2000-	1709 00T 42B	HU66T6	MEG/CR					X			X
	MARBELLA	1997-	1382 0T1 107	HU49T5	TEMIC	X	X					X	
	TOLEDO	1995-1999	1382 0T1 107	HU49T5	PH	X	X					X	
	TOLEDO	1999-	1709 00T 19B	HU66T5	MEG		X					X	

# ÜBERSICHT NACH KFZ- HERSTELLERN



HERSTELLER	MODELL	BAUJAHR	SCHLÜSSEL-NR.		ORIGINAL-TRANSPONDER	DATENTRANSFER							
			BÖRKEY	SILCA		BÖRKEY			WERKSTATT	SILCA			
						TLKG I	TLKG II	DIAGNOSE		MASTER-SCHLÜSSEL	JEDER SCHLÜSSEL	RW2	SDD
<b>SKODA</b>													
	FABIA	2000-	1709 00T 420	HU66AT6	MEG/CR						X		X
	FELICIA	1996-1998	1730 00T 100	SK22RT1	PH		X					X	
	FELICIA	1998-	1709 00T 190	HU66AT5	PH		X					X	
	OCTAVIA	1997-2000	1709 00T 190	HU66AT5	MEG		X					X	
	OCTAVIA	2001-	1709 00T 42B	HU66T6	MEG/CR					X			X
	PIK-UP	1996-1998	1730 00T 100	SK22RT1	PH		X					X	
	PIK-UP	1998-	1709 00T 190	HU66AT5	PH		X					X	
<b>SUBARU</b>													
	IMPREZA	1996-2000	1362 00T 100	NSN11T2	PH		X					X	
	JUSTY	1996-	1537 00T 310	SZ12T4	TEXAS						X		
	LEGACY OUTBACK	1996-	1362 00T 100	NSN11T2	PH		X					X	
<b>SUZUKI</b>													
	ALTO	1996-	1537 00T 310	SZ12T4	TEXAS						X		
	ALTO	1996-	1530 00T 310	SZ11RT4	TEXAS						X		
	BALENO	1996-	1530 00T 310	SZ11RT4	TEXAS						X		
	BALENO	1996-	1537 00T 310	SZ12T4	TEXAS						X		
	JIMNY	1999-	1530 00T 310	SZ11RT4	TEXAS						X		
	SWIFT	1996-	1537 00T 310	SZ12T4	TEXAS						X		
	SWIFT	1996-	1530 00T 310	SZ11RT4	TEXAS						X		
	VITARA	1996-	1530 00T 310	SZ11RT4	TEXAS						X		
	VITARA	1996-	1537 00T 310	SZ12T4	TEXAS						X		
	WAGON R	1998-2000	1530 00T 310	SZ11RT4	TEXAS						X		
<b>TOYOTA</b>													
	4-RUNNER LIMITED	1999-	1623 00T 310	TOY43AT4	TEXAS						X		
	ARISTO	1998-	1796 00T 310	TOY48BT4	TEXAS						X		
	AVALON XL	1998-	1623 00T 310	TOY43AT4	TEXAS						X		
	AVALON XLS	1998-	1623 00T 310	TOY43AT4	TEXAS						X		
	AVENSIS	1998-2000	1697 00T 310	TOY47T4	TEXAS						X		
	CAMRY	1997-	1623 00T 310	TOY43AT4	TEXAS						X		
	CAMRY XLE, XL	1998-	1623 00T 310	TOY43AT4	TEXAS						X		
	CARINA	1996-	1623 00T 10A	TOY43T2	PH		X					X	
	CARINA	1996-	1697 00T 310	TOY47T4	TEXAS						X		
	CELICA	1996-2000	1623 00T 10A	TOY43T2	PH		X					X	
	CELICA	2000-	1623 00T 310	TOY43AT4	TEXAS						X		
	CELSIOR	1998-	1558 00T 31A	TOY40BT4	TEXAS						X		
	CELSIOR	1998-	1796 00T 310	TOY48BT4	TEXAS						X		
	COLORADA	1997-	1623 00T 310	TOY43AT4	TEXAS						X		
	COROLLA	1996-1999	1623 00T 300	TOY43T3	TEXAS						X		
	COROLLA	1996-1999	1675 00T 300	TOY46RT3	TEXAS						X		
	COROLLA	1999-	1623 00T 310	TOY43AT4	TEXAS						X		
	ECHO	1999-	1489 00T 19B	TOY41RAT4	TEXAS						X		
	HIACE	1997-	1623 00T 310	TOY43AT4	TEXAS						X		
	HIGHLANDER	2001-	1623 00T 310	TOY43AT4	TEXAS						X		
	LANDCRUISER	1996-	1623 00T 310	TOY43AT4	TEXAS						X		
	LANDCRUISER 100 S	1996-	1558 00T 31A	TOY40BT4	TEXAS						X		
	MR2	1997-	1489 00T 31A	TOY41RT4	TEXAS						X		
	PASEO	1997-	1764 00T 190	TOY42AT5	PH		X					X	
	PICNIC	1996-	1623 00T 310	TOY43AT4	TEXAS						X		
	PRADO	1996-	1623 00T 310	TOY43AT4	TEXAS						X		
	PREVIA	1997-	1764 00T 190	TOY42AT5	PH		X					X	
	PRIUS	2001-	1623 00T 310	TOY43AT4	TEXAS						X		
	PROGRESS NC300	1998-	1796 00T 310	TOY48BT4	TEXAS						X		

HERSTELLER	MODELL	BAUJAHR	SCHLÜSSEL-NR.		ORIGINAL- TRANSPONDER	DATENTRANSFER							
			BÖRKEY	SILCA		BÖRKEY			Werkstatt	SILCA			
						TLKG I	TLKG II	DIAGNOSE		MASTER-Schlüssel	Jeder Schlüssel	RW2	SDD
<b>TOYOTA</b>													
	RAV 4	1996-	1623 00T 300	TOY43T3	TEXAS						X		
	SEQUOIA	2001-	1623 00T 310	TOY43AT4	TEXAS						X		
	SIENNA	1999-	1623 00T 310	TOY43AT4	TEXAS						X		
	SOLARA	1999-	1623 00T 310	TOY43AT4	TEXAS						X		
	STARLET	1997-	1489 00T 19B	TOY41RAT5	PH		X					X	
	YARIS	1999-	1489 00T 19B	TOY41RAT4	TEXAS						X		
<b>VOLKSWAGEN</b>													
	BEETLE	1998-	1709 00T 42B	HU66T6	MEG/CR			X					
	BORA	1998-	1709 00T 42B	HU66T6	MEG/CR			X					
	CADDY	1995-1999	1382 0T1 107	HU49T5	PH	X	X					X	
	GOLF	1995-1999	1382 0T1 107	HU49T5	PH	X	X					X	
	GOLF	1998-	1709 00T 42B	HU66T6	MEG/CR			X					
	GOLF CABRIO	1995-1998	1382 0T1 107	HU49T5	PH	X	X					X	
	GOLF CABRIO	1998-2000	1709 00T 01B	HU66T10	PH/CR					X			X
	JETTA	2000-	1709 00T 42B	HU66T6	MEG/CR			X					
	LT 28	2000-	0892 00T 190	YM15T5	TEMIC		X					X	
	LUPO	1998-2000	1709 00T 01B	HU66T10	PH/CR					X			X
	PASSAT	1995-1997	1382 0T1 107	HU49T5	PH	X	X					X	
	PASSAT	1997-1998	1709 00T 19B	HU66T5	MEG		X					X	
	PASSAT	1998-	1709 00T 42B	HU66T6	MEG/CR			X					X
	POLO	1995-1998	1382 0T1 107	HU49T5	PH	X	X					X	
	POLO	1998-2000	1709 00T 01B	HU66T10	PH/CR					X			X
	SAVEIRO	1999-	1382 50T 42A	HU49RT6	MEG/CR			X					X
	SHARAN	1995-1998	1709 00T 19B	HU66T5	PH		X					X	
	SHARAN	1998-2000	1709 00T 01B	HU66T10	PH/CR					X			X
	TRANSPORTER	1995-1998	1382 0T1 107	HU49T5	PH	X	X					X	
	TRANSPORTER	1998-	1709 00T 01B	HU49T10	PH/CR					X			X
	VENTO	1995-	1382 0T1 107	HU49T5	PH	X	X					X	
<b>VOLVO</b>													
	850	1996-	1480 00T 100	NE66T2	PH		X					X	
	940	1996-	1364 00T 100	NE51T2	PH		X					X	
	960	1996-1997	1480 00T 100	NE66T2	PH		X					X	
	C70	1997-1998	1480 00T 100	NE66T2	PH		X					X	
	POLAR	1996-	1364 00T 100	NE51T2	PH		X					X	
	S40	1996-	1474 00T 100	HU56RAT2	PH		X					X	
	S70	1997-1998	1480 00T 100	NE66T2	PH		X					X	
	V40	1996-1998	1474 00T 100	HU56RAT2	PH		X					X	
	V70	1997-1998	1480 00T 100	NE66T2	PH		X					X	
<b>YAMAHA</b>													
	AEROX	1998-	1766 0LT 190	ZD24RT5	MEG		X					X	
	NEOS	1998-	1766 0LT 190	ZD24RT5	MEG		X					X	

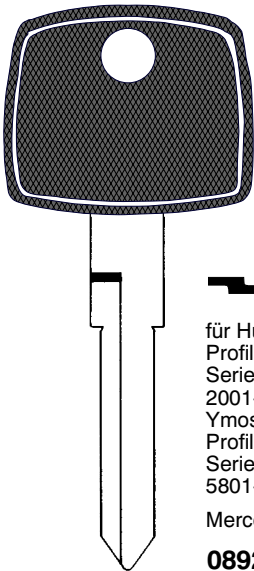

für Huf + Ymos  
Profile HM + NF  
Serien 1-4000,  
2001-3500,  
Ymos  
Profil HM  
Serien 4001-5795,  
5801-7350  
Mercedes, VW  
**0892 00T 190**  
YM15T5

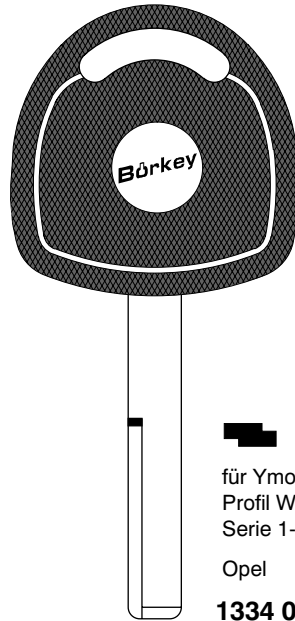

für Ymos  
Profil WY  
Serie 1-3000  
Opel

**1334 00T 100**  
YM27T5

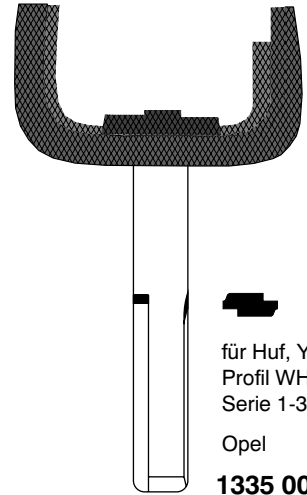

für Huf, Ymos  
Profil WH, H  
Serie 1-3000

Opel  
**1335 00T 09A**  
HU43AT9

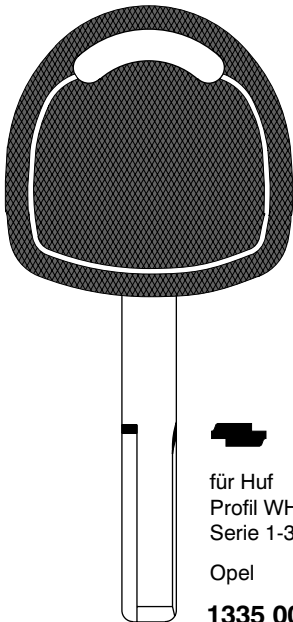

für Huf  
Profil WH  
Serie 1-3000  
Opel

**1335 00T 100**  
HU43T2

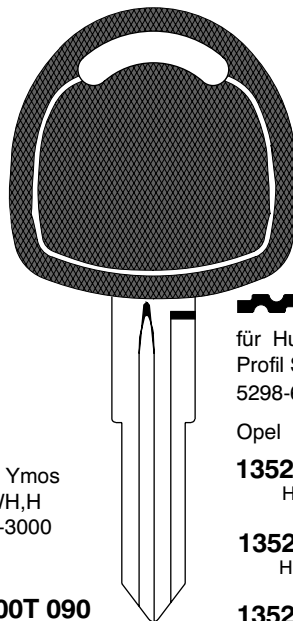

für Huf  
Profil S, Serien 1-5200,  
5298-6300

Opel  
**1352 00T 100**  
HU46T2

**1352 00T 020**  
HU46T12

**1352 00T 090**  
HU46T9

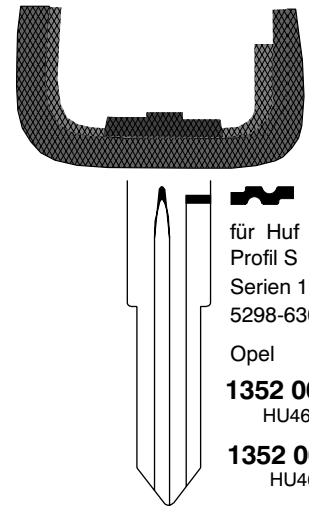

für Huf  
Profil S  
Serien 1-5200  
5298-6300

Opel  
**1352 00T 02A**  
HU46AT12

**1352 00T 09A**  
HU46AT9

für Ymos  
Profil D, Serien 1-5200

Opel  
**1352 50T 100**  
YM28T2

für Ymos, Valeo  
Profil D  
Serie 1-5200

**1352 50T 02A**  
YM28AT12

**1352 50T 09A**  
YM28AT9

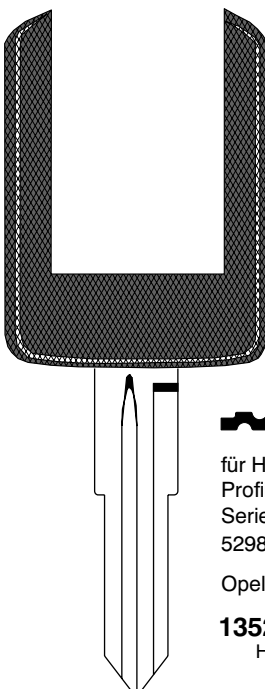

für Huf  
Profil S  
Serien 1-2000, 4001-5200,  
5298-6300

Opel  
**1352 00T 02B**  
HU46BT12

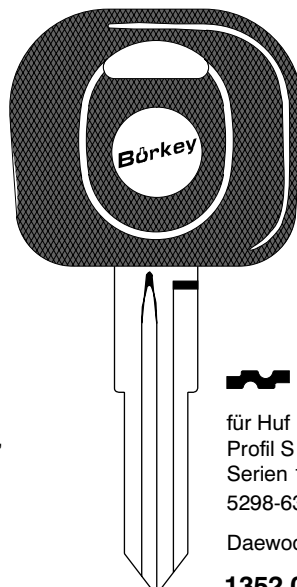

für Huf  
Profil S  
Serien 1-2000, 4001-5200,  
5298-6300

Daewoo  
**1352 00T 19A**  
HU46AT5

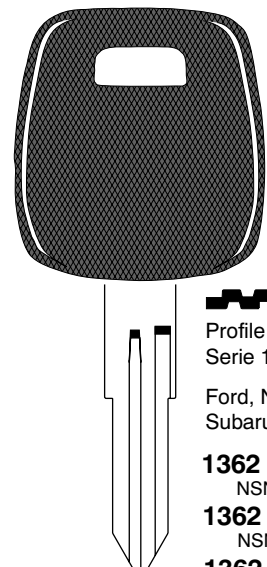

Profile X + Y  
Serie 1-9000

Ford, Nissan,  
Subaru

**1362 00T 030**  
NSN11T13

**1362 00T 110**  
NSN11T11

**1362 00T 100**  
NSN11T2 10

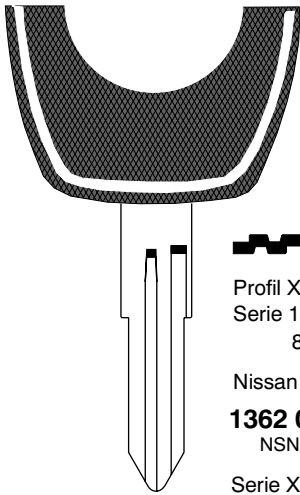

  
 Profil X  
 Serie 1-8000  
 8001-9000  
  
 Nissan  
**1362 00T 03A**  
 NSN11AT13  
 Serie X 1-9000  
**1362 00T 11A**  
 NSN11AT11

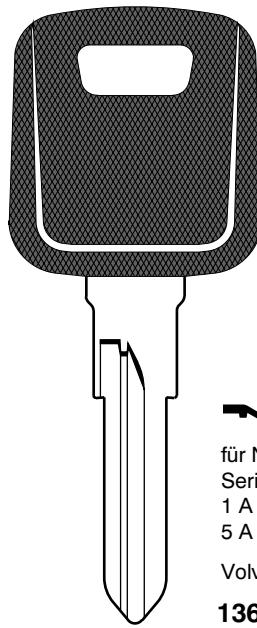

  
 für Neiman  
 Serien  
 1 A 000-4 B 999  
 5 A 000-5 B 745  
  
 Volvo  
**1364 00T 100**  
 NE51T2

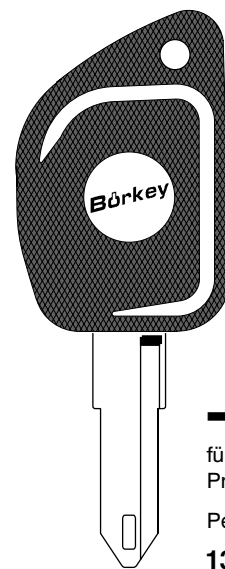

  
 für Neiman  
 Profile B, 1, 2, 5  
 Peugeot  
**1374 0BT 190**  
 NE72AT5

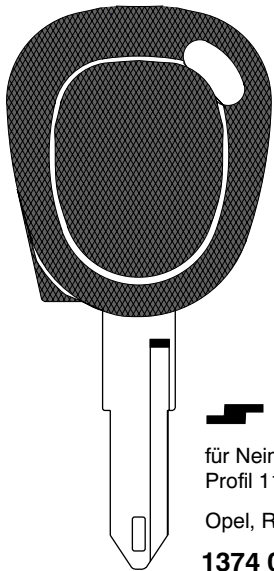

  
 für Neiman  
 Profil 11  
 Opel, Renault  
**1374 0LT 190**  
 NE73T5

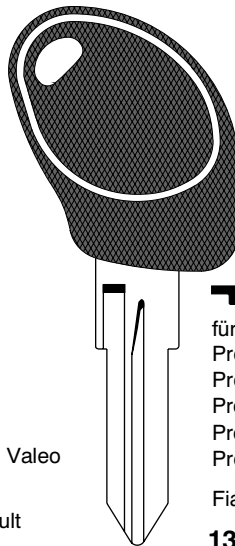

für Neiman, Valeo  
 M-N-P-R-S  
 Opel, Renault  
**1374 0LT 080**  
 NE73T8

  
 für Sipea  
 Profil AB, Serie 6001-6891  
 Profil J, Serie 3001-6732  
 Profil N, Serie 6001-7000  
 Profil V, Serie 0001-3056  
 Profil V, Serie 5001-8058  
  
 Fiat  
**1375 00T 190**  
 GT10BT5

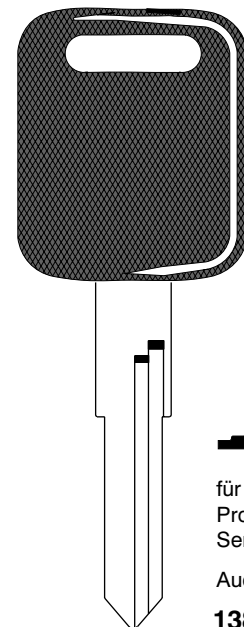

  
 für Huf  
 Profil AH  
 Serie 1-9282  
 Audi  
**1382 00T 190**  
 HU49AT5



  
 für Huf, Witte  
 Profil AH  
 Serie 1-9282  
 Seat, VW  
**1382 0T1 107**  
 HU49T5

  
 VW  
**1382 50T 42A**  
 HU49RT6

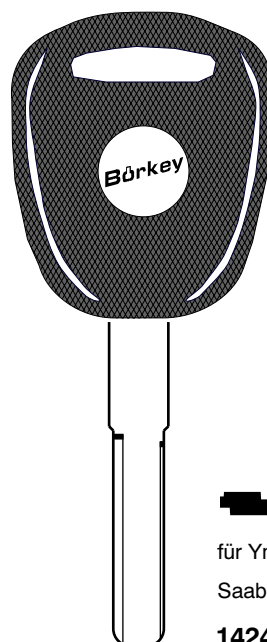

  
 für Ymos  
 Saab  
**1424 00T 190**  
 YM30T5

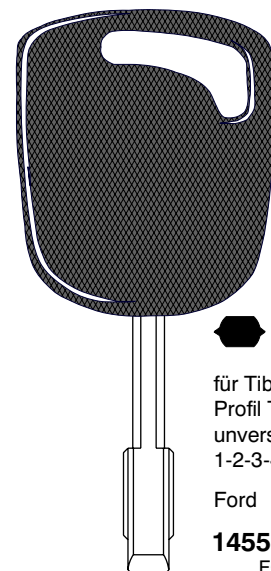

  
 für Tibbe  
 Profil T  
 unverschlüsselt  
 1-2-3-4  
 Ford  
**1455 00T 300**  
 FO21T3  
**1455 00T 320**  
 FO21T7

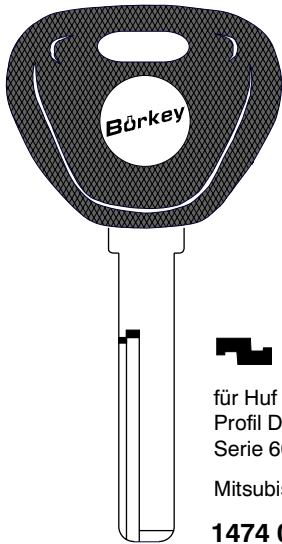

für Huf  
 Profil DH  
 Serie 6001-8000

Mitsubishi

**1474 00T 10A**  
 HU56RT2

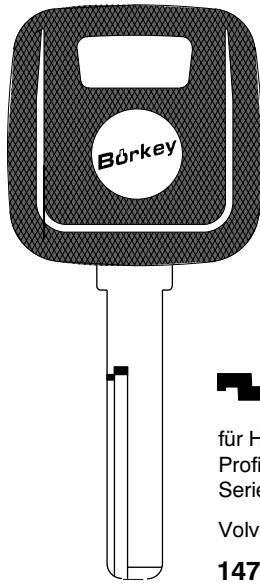

für Huf  
 Profil DH  
 Serie 6001-8000

Volvo

**1474 00T 100**  
 HU56RAT2

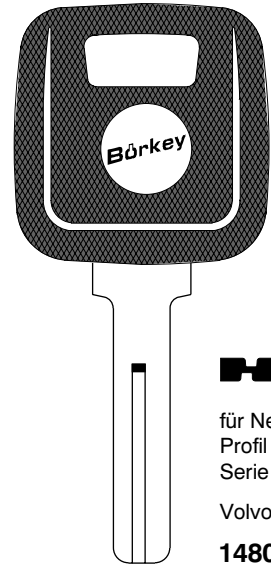

für Neiman  
 Profil V  
 Serie 1-12295

Volvo

**1480 00T 100**  
 NE66T2

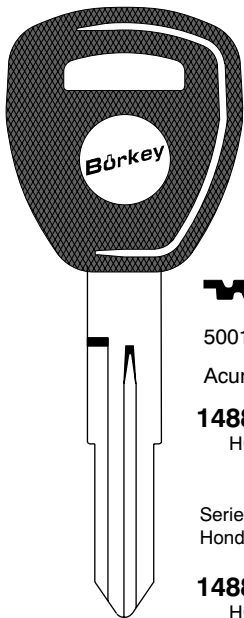

5001-8442  
 Acura, Honda

**1488 0LT 190**  
 HON58RT5

Serie 5001-8442  
 Honda

**1488 0LT 420**  
 HON58RT6

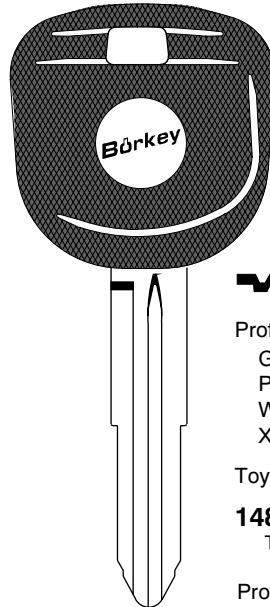

Profil Serie  
 G 1-2377  
 P 1-2390  
 W 1-2409  
 X 1-2248

Toyota

**1489 00T 19B**  
 TOY41RAT5

Profile D, P Serie 1-2000

Daihatsu

**1489 00T 310**  
 DH4RT4

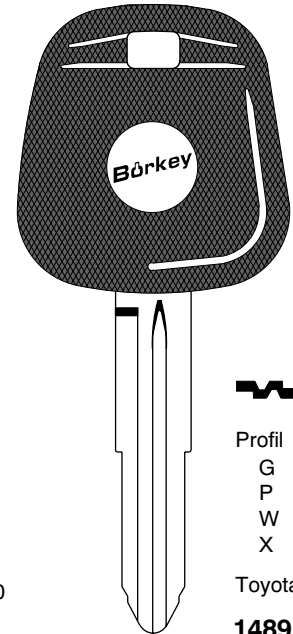

Profil Serie  
 G 1-2377  
 P 1-2390  
 W 1-2409  
 X 1-2248

Toyota

**1489 00T 31A**  
 TOY41RT4

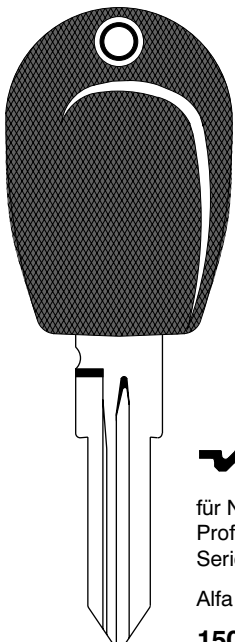

für Neiman  
 Profil W  
 Serie 0001-9640

Alfa Romeo

**1505 0NT 100**  
 GT15RT2

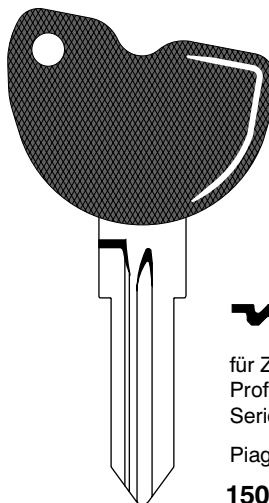

für Zadi  
 Profil W  
 Serie 0001-9640

Piaggio

**1505 0NT 19A**  
 GT15RDT5

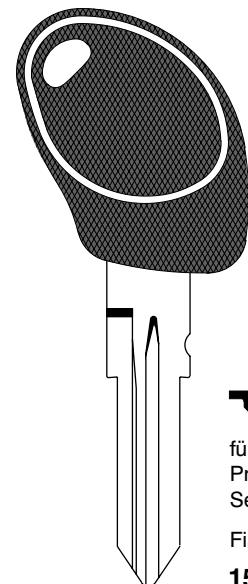

für Sipea  
 Profil W  
 Serie 0001-9640

Fiat

**1505 0NT 19B**  
 GT15RBT5

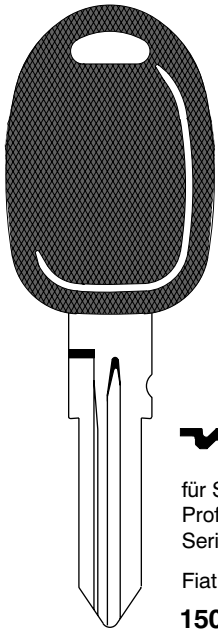

für Sipea  
Profil W  
Serie 0001-9640

Fiat

**1505 0NT 19C**  
GT15RCT5

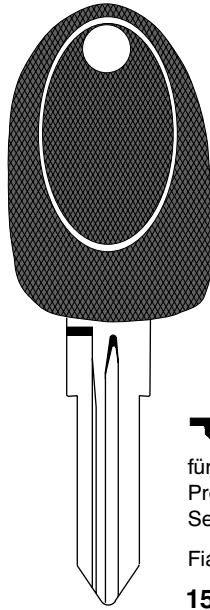

für Sipea  
Profil W  
Serie 0001-9640

Fiat

**1505 0NT 19D**  
GT15RAT5

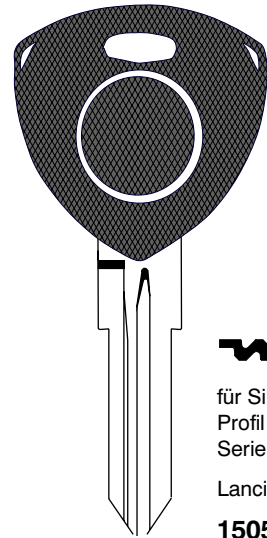

für Sipea  
Profil W  
Serie 0001 - 9640  
Lancia

**1505 0NT 19E**  
GT18RT5

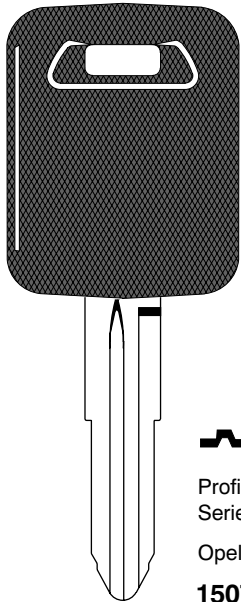

Profil N  
Serie 5001-7000

Opel

**1507 00T 190**  
GM15T5

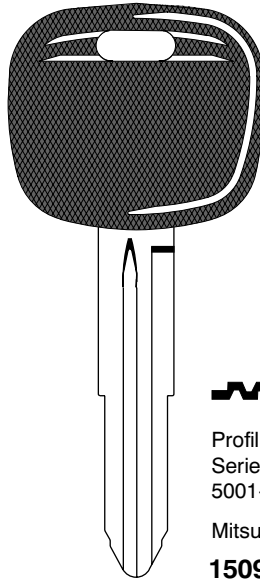

Profil E  
Serien  
5001-7679

Mitsubishi

**1509 00T 310**  
MIT8T4

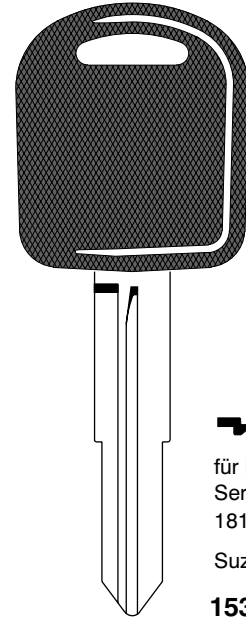

für Neimann  
Serie  
18100 - 19229

Suzuki

**1530 00T 310**  
SZ11RT4

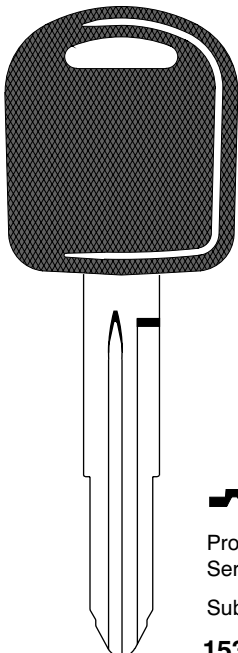

Profil U  
Serie 1-2000  
Subaru, Suzuki

**1537 00T 310**  
SZ12T4

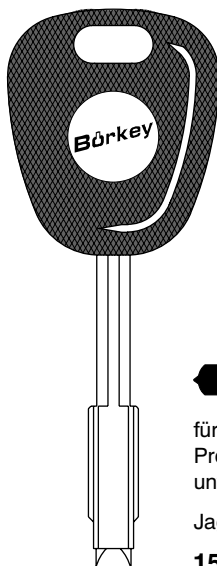

für Tibbe  
Profil T  
unverschl.

Jaguar

**1538 00T 190**  
TBE1T5

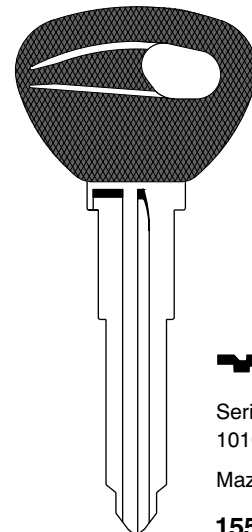

Serie  
10100-12099

Mazda, Ford

**1556 00T 190**  
MAZ13T5

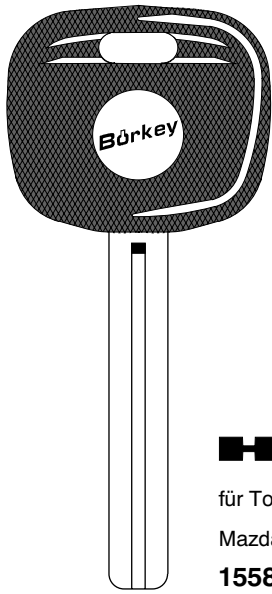

für Tohaj-Rika  
Mazda, Mitsubishi  
**1558 00T 190**  
MIT14T5

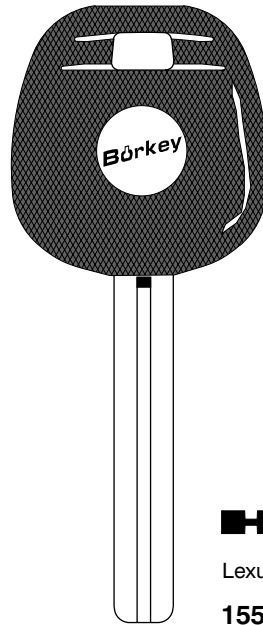

Lexus, Toyota  
**1558 00T 31A**  
TOY40BT4

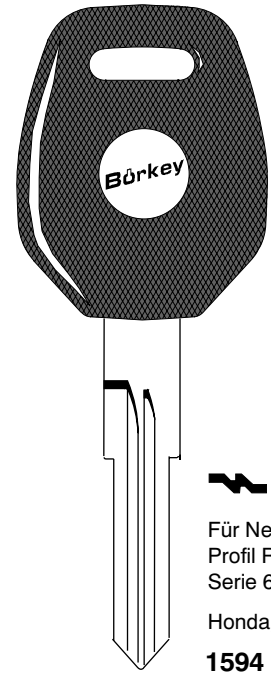

Für Neiman  
Profil R  
Serie 6001-8000  
Honda, Rover  
**1594 00T 100**  
NE77RT2

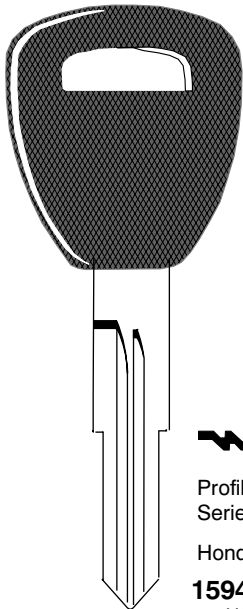

Profil R  
Serie 1-1706  
Honda  
**1594 0NT 420**  
HON65RT6

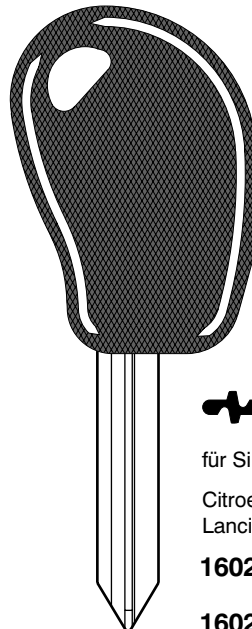

für Simplex  
Citroen, Fiat  
Lancia, Peugeot  
**1602 00T 190**  
SX9T5  
**1602 00T 420**  
SX9T6

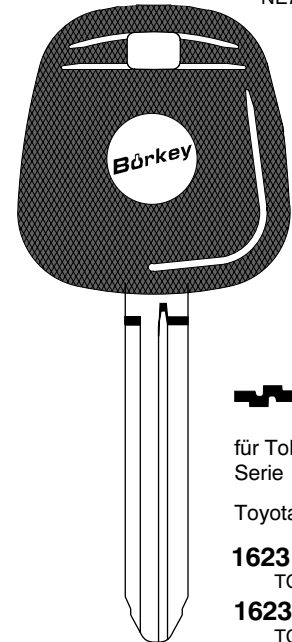

für Tokaj-Rika  
Serie 1-5000  
Toyota  
**1623 00T 10A**  
TOY43T2  
**1623 00T 300**  
TOY43T3

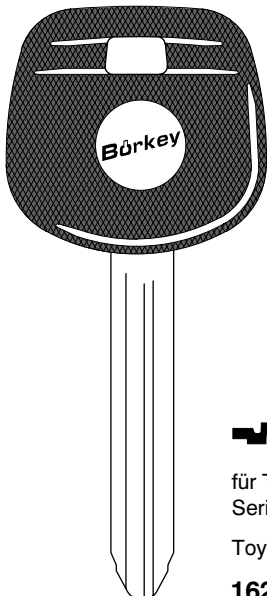

für Tokaj-Rika  
Serie 1-5000  
Toyota  
**1623 00T 310**  
TOY43AT4

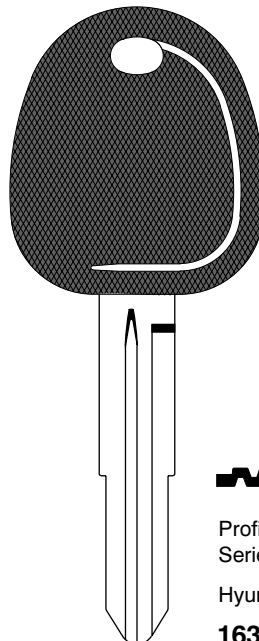

Profil T  
Serie 1 - 1000  
Hyundai  
**1638 00T 310**  
HYN6T4

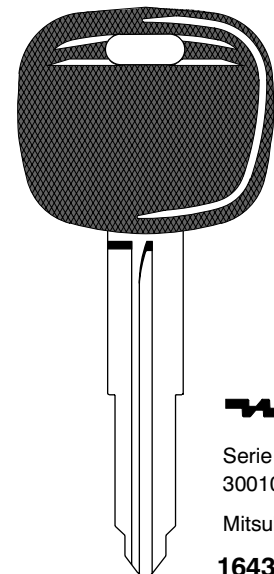

Serie  
30010-32005  
Mitsubishi  
**1643 00T 310**  
MIT11RT4

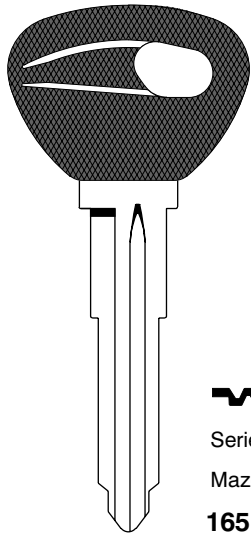

  
 Serie 10100-12099  
 Mazda  
**1651 00T 190**  
 MAZ20RT5

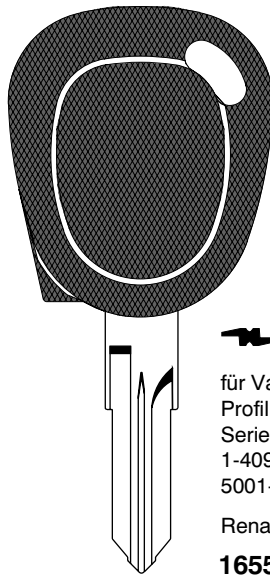

  
 für Vachette  
 Profil A9-Z9  
 Serien  
 1-4092  
 5001-9092  
 Renault  
**1655 00T 100**  
 VAC102T1

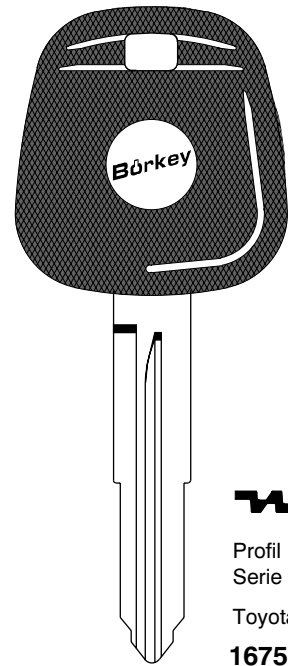

  
 Profil N  
 Serie 1-2000  
 Toyota  
**1675 00T 300**  
 TOY46RT3

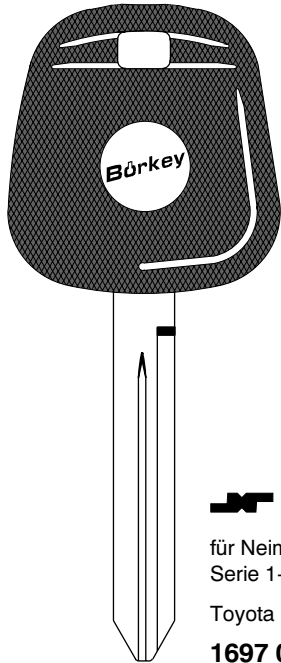

  
 für Neiman, Valeo  
 Serie 1-13284  
 Toyota  
**1697 00T 310**  
 TOY47T4

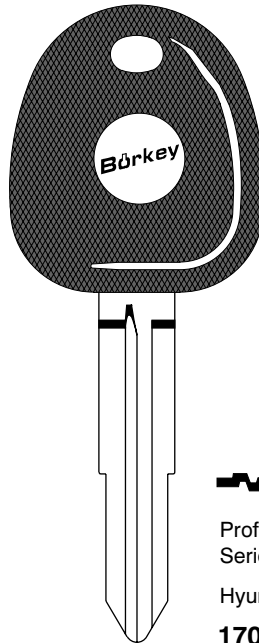

  
 Profil R  
 Serie 1-1000  
 Hyundai  
**1700 00T 310**  
 HYN10T4

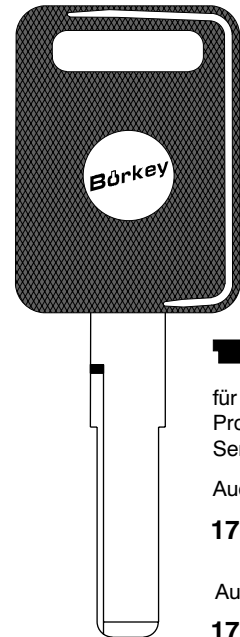

  
 für Huf, Witte  
 Profil HAA  
 Serie 1-2000  
 Audi, Skoda  
**1709 00T 190**  
 HU66AT5  
 Audi  
**1709 00T 420**  
 HU66AT6

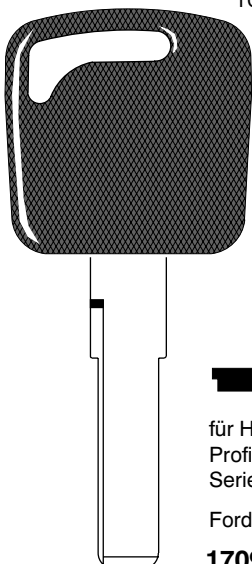

  
 für Huf, Witte  
 Profil HAA  
 Serie 1-2000  
 Ford  
**1709 00T 10A**  
 HU66BT1



  
 für Huf, Witte  
 Profil HAA  
 Serie 1-2000  
 Porsche, Seat, VW  
**1709 00T 19B**  
 HU66T5  
 VW  
**1709 00T 42B**  
 HU66T6

Profil S  
 Serie 1-5200  
 5268-6300  
 Seat, VW  
**1709 00T 01B**  
 HU66T10

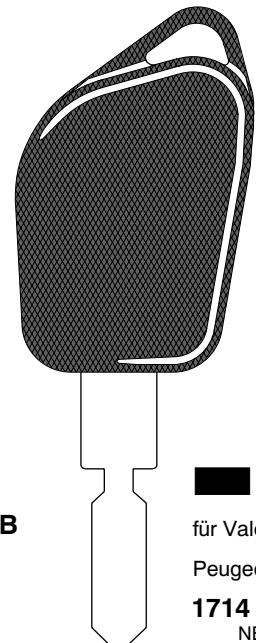

  
 für Valeo  
 Peugeot  
**1714 00T 190**  
 NE78T5

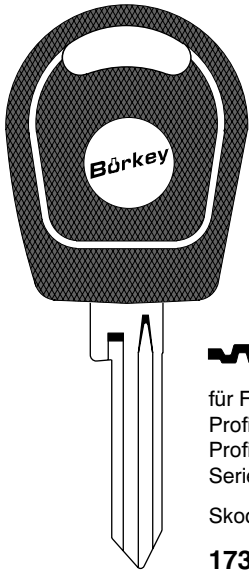

für FAB  
 Profil 4AB  
 Profil 4AE  
 Serie 1-2780  
 Skoda

**1730 00T 100**  
 SK22RT1

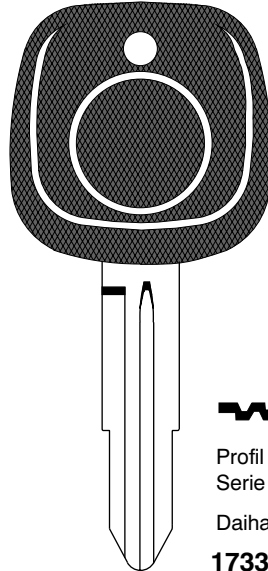

Profil D  
 Serie 3001-4000  
 Daihatsu

**1733 00T 310**  
 DH5RT4

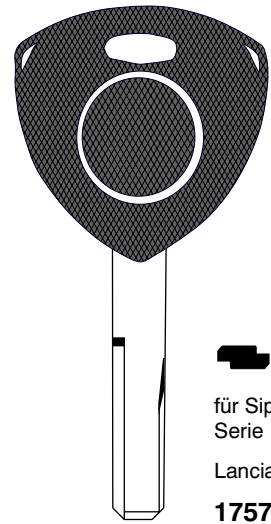

für Sipea  
 Serie 1-17357  
 Lancia

**1757 00T 130**  
 SIP16T2

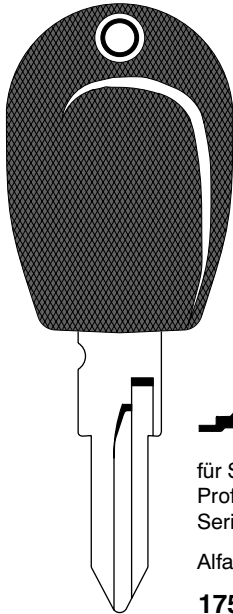

für Sipea  
 Profil H, K  
 Serie 7001-8092  
 Alfa Romeo

**1758 00T 100**  
 GT16T2

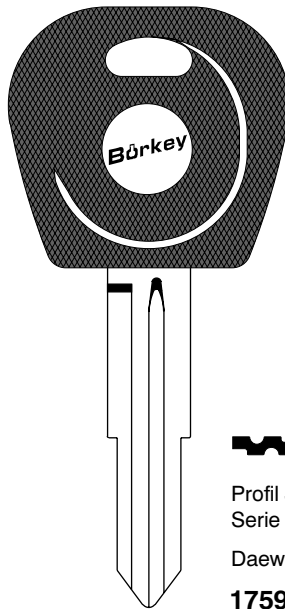

Profil J  
 Serie 1-1200  
 Daewoo

**1759 0LT 190**  
 DWO4RT5

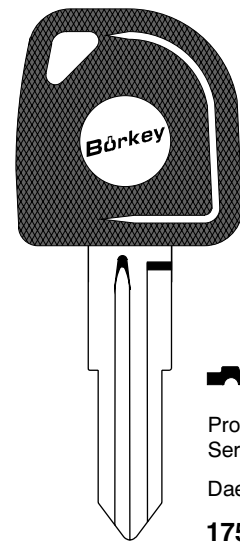

Profil M  
 Serie 1-1200  
 Daewoo

**1759 5KT 19A**  
 DWO6BT5

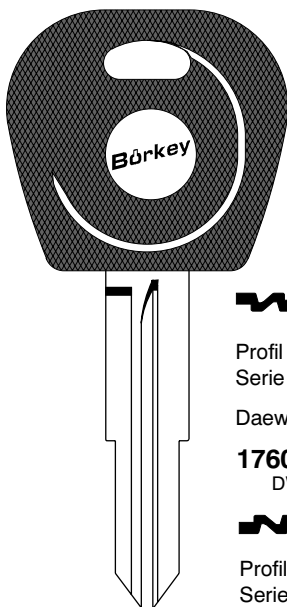

Profil T  
 Serie 1-1200  
 Daewoo

**1760 00T 190**  
 DWO5RT5



Profil V  
 Serie 1-1200  
 Daewoo

**1760 50T 190**  
 DWO5T5

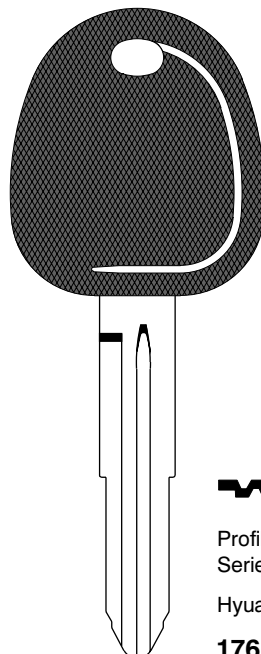

Profil S  
 Serie 1-1000  
 Hyuandai

**1761 00T 310**  
 HYN7RT4

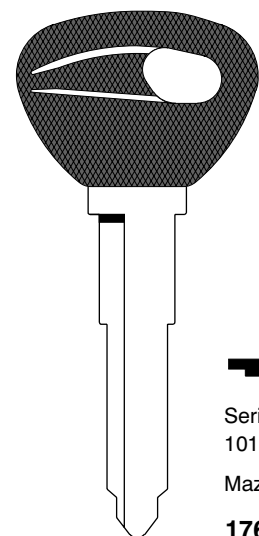

Serie  
 10100-12099

Mazda

**1762 00T 190**  
 MAZ24RT5

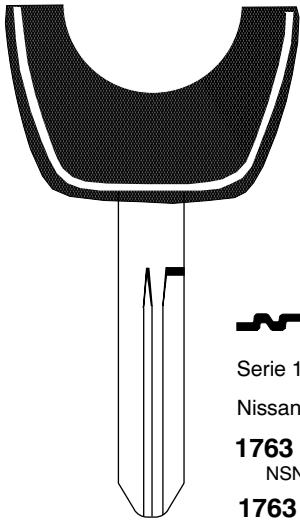

Serie 1-22185  
Nissan  
**1763 00T 03A**  
NSN11AT13  
**1763 00T 11A**  
NSN14AT11

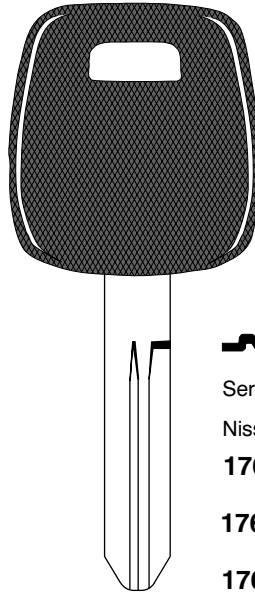

Serie 1-22185  
Nissan  
**1763 00T 030**  
NSN14T13  
**1763 00T 110**  
NSN14T11  
**1763 00T 190**  
NSN14T5

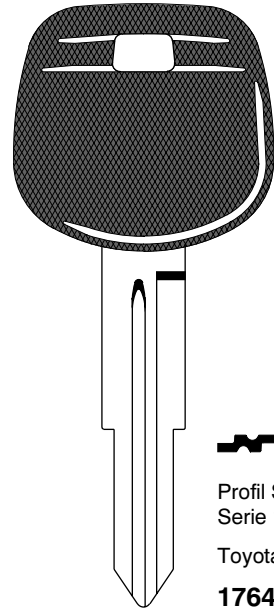

Profil S  
Serie 1-2878  
Toyota  
**1764 00T 190**  
TOY42AT5

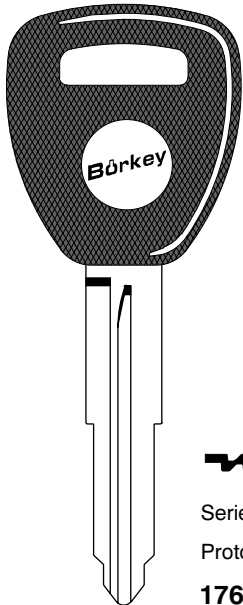

Serie 30010-32009  
Proton  
**1765 00T 310**  
PO1RT4

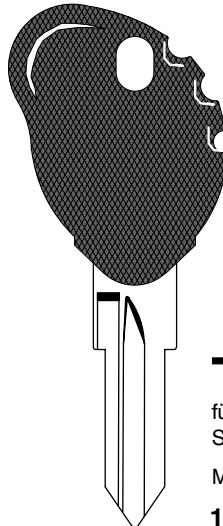

für Zadi  
Serie 8001-9554  
Malaguti, MBK  
**1766 00T 190**  
ZD23T5

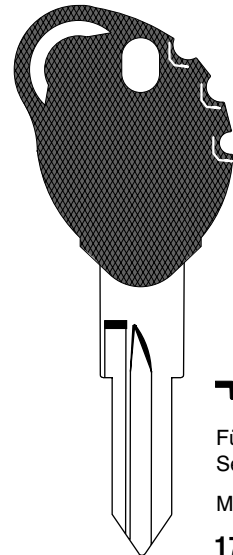

Für Zadi  
Serie 8001-9554  
MBK, Yamaha  
**1766 0LT 190**  
ZD524RT5

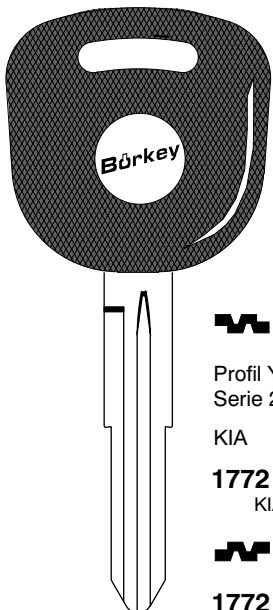

Profil Y  
Serie 2001-3000  
KIA  
**1772 00T 190**  
KIA3RT5



**1772 50T 190**  
KIA3T5

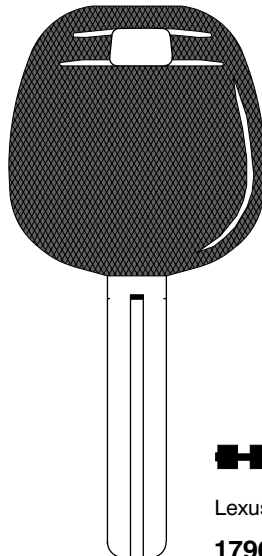

Lexus, Toyota  
**1796 00T 310**  
TOY48BT4

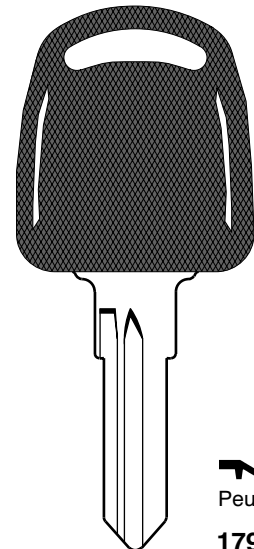

Peugeot  
**1797 00T 190**  
NE74T5

# Transponderschlüssel - Vergleichsliste



BORKEY		SILCA		BORKEY		SILCA		SILCA		BORKEY		SILCA		BORKEY	
0892 00T 190	YM15T5	1538 00T 190	TBE1T5	DH4RT4	1489 00T 310	MAZ24RT5	1762 00T 190								
1334 00T 100	YM27T2	1556 00T 190	MAZ13T5	DH5RT4	1733 00T 310	MIT11RT4	1643 00T 310								
1335 00T 090	HU43T9	1558 00T 190	MIT14T5	DWO4RT5	1759 00T 190	MIT14T5	1558 00T 190								
1335 00T 09A	HU43AT9	1558 00T 31A	TOY40BT4	DWO5RT5	1760 00T 190	MIT8T4	1509 00T 310								
1335 00T 100	HU43T2	1594 00T 100	NE77RT2	DWO5T5	1760 50T 190	NE51T2	1364 00T 100								
1352 00T 020	HU46T12	1594 00T 420	HON65RT6	DWO6BT5	1759 5KT 19A	NE66T2	1480 00T 100								
1352 00T 02A	HU46AT12	1602 00T 190	SX9T5	FO21T3	1455 00T 300	NE72AT5	1374 00T 190								
1352 00T 02B	HU46BT12	1602 00T 420	SX9T6	FO21T7	1455 00T 320	NE73T5	1374 00T 190								
1352 00T 090	HU46T9	1623 00T 10A	TOY43T2	GM15T5	1507 00T 190	NE73T8	1374 00T 080								
1352 00T 100	HU46T2	1623 00T 300	TOY43T3	GT10BT5	1375 00T 190	NE74T5	1797 00T 190								
1352 00T 19A	HU46AT5	1623 00T310	TOY43AT4	GT15RAT5	1505 00T 19D	NE77RT2	1594 00T 100								
1352 50T 02A	YM28AT12	1638 00T 310	HYN6T4	GT15RBT5	1505 00T 19B	NE78T5	1714 00T 190								
1352 50T 09A	YM28AT9	1643 00T 310	MIT11RT4	GT15RCT5	1505 00T 19C	NSN11AT11	1362 00T 11A								
1352 00T 09A	HU46AT9	1651 00T 190	MAZ20RT5	GT15RDT5	1505 00T 19A	NSN11AT13	1362 00T 03A								
1352 50T 100	YM28T2	1655 00T 100	VAC102T1	GT15RT2	1505 00T 100	NSN11T11	1362 00T 110								
1362 00T 030	NSN11T13	1675 00T 300	TOY46RT3	GT16T2	1758 00T 100	NSN11T13	1362 00T 030								
1362 00T 03A	NSN11AT13	1697 00T 310	TOY47T4	GT18RT5	1505 00T 19E	NSN11T2	1362 00T 100								
1362 00T 100	NSN11T2	1700 00T 310	HYN10T4	HON58RT5	1488 00T 190	NSN14AT11	1763 00T 11A								
1362 00T 110	NSN11T11	1709 00T 42B	HU66T6	HON58RT6	1488 00T 420	NSN14AT13	1763 00T 03A								
1362 00T 11A	NSN11AT11	1709 00T 01B	HU66T10	HON65RT6	1594 00T 420	NSN14T11	1763 00T 110								
1364 00T 100	NE51T2	1709 00T 10A	HU66BT1	HU43AT9	1335 00T 09A	NSN14T13	1763 00T 030								
1374 00T 190	NE72AT5	1709 00T 190	HU66AT5	HU43T2	1335 00T 100	NSN14T5	1763 00T 190								
1374 00T 080	NE73T8	1709 00T 19B	HU66T5	HU43T9	1335 00T 090	PO1RT4	1765 00T 310								
1374 00T 190	NE73T5	1709 00T 420	HU66AT6	HU46T12	1352 00T 020	SIP16T2	1757 00T 130								
1375 00T 190	GT10BT5	1709 00T 42B	HU66T6	HU46AT12	1352 00T 02A	SK22RT1	1730 00T 100								
1382 00T 190	HU49AT5	1714 00T 190	NE78T5	HU46AT5	1352 00T 19A	SX9T5	1602 00T 190								
1382 00T 19A	HU49T5	1730 00T 100	SK22RT1	HU46AT9	1352 00T 09A	SX9T6	1602 00T 420								
1382 50T 42A	HU49RT6	1733 00T 310	DH5RT4	HU46BT12	1352 00T 02B	SZ11RT4	1530 00T 310								
1424 00T 190	YM30T5	1757 00T 130	SIP16T2	HU46T2	1352 00T 100	SZ12T4	1537 00T 310								
1455 00T 300	FO21T3	1758 00T 100	GT16T2	HU46T9	1352 00T 090	TBE1T5	1538 00T 190								
1455 00T 320	FO21T7	1759 00T 190	DWO4RT5	HU49AT5	1382 00T 190	TOY40BT4	1558 00T 31A								
1474 00T 100	HU56RAT2	1759 5KT 19A	DWO6BT5	HU49RT6	1382 00T 420	TOY41RAT5	1489 00T 19B								
1474 00T 10A	HU56RT2	1760 00T 190	DWO5RT5	HU49T5	1382 00T 19A	TOY41RT4	1489 00T 31A								
1480 00T 100	NE66T2	1760 50T 190	DWO5T5	HU56RAT2	1474 00T 100	TOY42AT5	1764 00T 190								
1488 00T 190	HON58RT5	1761 00T 310	HYN7RT4	HU56RT2	1474 00T 10A	TOY43AT4	1623 00T310								
1488 00T 420	HON58RT6	1762 00T 190	MAZ24RT5	HU66AT5	1709 00T 190	TOY43T2	1623 00T 10A								
1489 00T 19B	TOY41RAT5	1763 000 11A	NSN14AT11	HU66AT6	1709 00T 420	TOY43T3	1623 00T 300								
1489 00T 310	DH4RT4	1763 00T 030	NSN14T13	HU66BT1	1709 00T 10A	TOY46RT3	1675 00T 300								
1489 00T 31A	TOY41RT4	1763 00T 03A	NSN14AT13	HU66T10	1709 00T 01B	TOY47T4	1697 00T 310								
1505 00T 100	GT15RT2	1763 00T 110	NSN14T11	HU66T5	1709 00T 19B	TOY48BT4	1796 00T 310								
1505 00T 19A	GT15RDT5	1763 00T 190	NSN14T5	HU66T6	1709 00T 42B	VAC102T1	1655 00T 100								
1505 00T 19B	GT15RBT5	1764 00T 190	TOY42AT5	HU66T6	1709 00T 42B	YM15T5	0892 00T 190								
1505 00T 19C	GT15RCT5	1765 00T 310	PO1RT4	HYN10T4	1700 00T 310	YM27T2	1334 00T 100								
1505 00T 19D	GT15RAT5	1766 00T 190	ZD23RT5	HYN6T4	1638 00T 310	YM28AT12	1352 50T 02A								
1505 00T 19E	GT18RT5	1766 00T 190	ZD24RT5	HYN7RT4	1761 00T 310	YM28AT9	1352 50T 09A								
1507 00T 190	GM15T5	1772 00T 190	KIA3RT5	KIA3RT5	1772 00T 190	YM28T2	1352 50T 100								
1509 00T 310	MIT8T4	1772 50T 190	KIA3T5	KIA3T5	1772 50T 190	YM30T5	1424 00T 190								
1530 00T 310	SZ11RT4	1796 00T 310	TOY48BT4	MAZ13T5	1556 00T 190	ZD23RT5	1766 00T 190								
1537 00T 310	SZ12T4	1797 00T 190	NE74T5	MAZ20RT5	1651 00T 190	ZD24RT5	1766 00T 190								

# Transponder - Vergleichsliste

BÖRKEY		SILCA		BÖRKEY		SILCA		BÖRKEY		SILCA		BÖRKEY	
T01	T10	T13	T1/T2	T1/T2	T10	T 8	T08						
T02	T12	T19	T 5	T1/T2	T13	T 9	T09						
T03	T13	T30	T 3	T 3	T30	T10	T01						
T08	T 8	T31	T 4	T 4	T31	T11	T11						
T09	T 9	T32	T 7	T 5	T19	T12	T02						
T10	T1/T2	T42	T 6	T 6	T42	T13	T03						
T11	T11			T 7	T32								



**AUGUST BÖRKEY NACHF. GMBH**  
SCHLÜSSELFABRIKATION UND MASCHINENBAU  
Schlüsseldienstbedarf • Schließzylinder  
Schließanlagen mit Schließanlagenbrief • Zweckmöbel

D-58285 Gevelsberg, Geerstraße 4-12,  
Telefon 02332 / 7006-0 - Fax 7006-22  
E-Mail: [info@boerkey.de](mailto:info@boerkey.de)